



T H E

M3

M4



THE NEW BMW M3 SALOON.  
 THE NEW BMW M4 COMPETITION COUPÉ.  
 THE NEW BMW M4 COMPETITION CONVERTIBLE WITH M xDRIVE.



## INNOVATION AND TECHNOLOGY.



20 Powertrain and suspension



24 Connectivity and infotainment



25 Driver assistance

## EQUIPMENT.

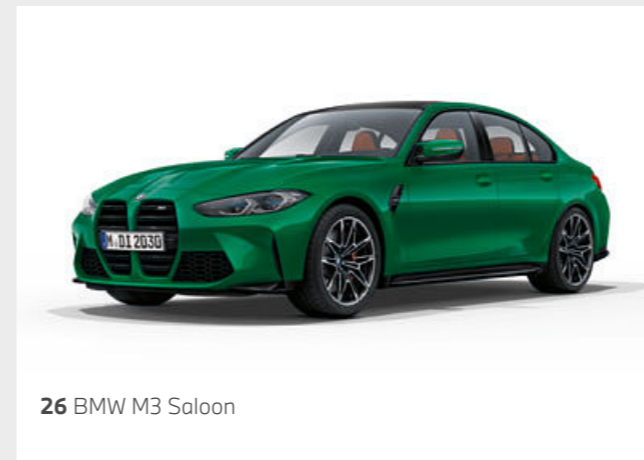

26 BMW M3 Saloon

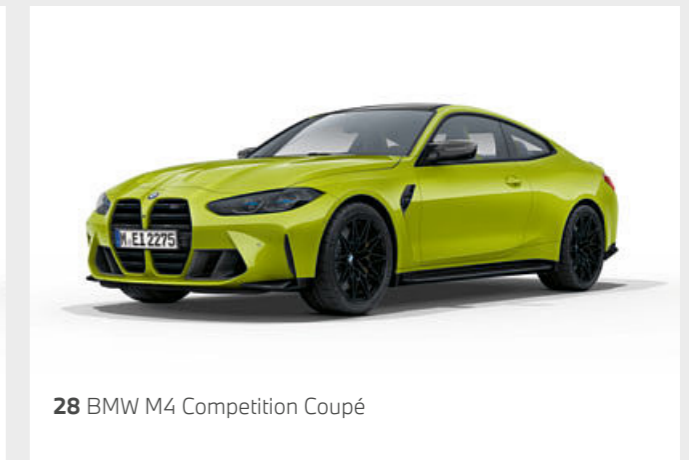

28 BMW M4 Competition Coupé

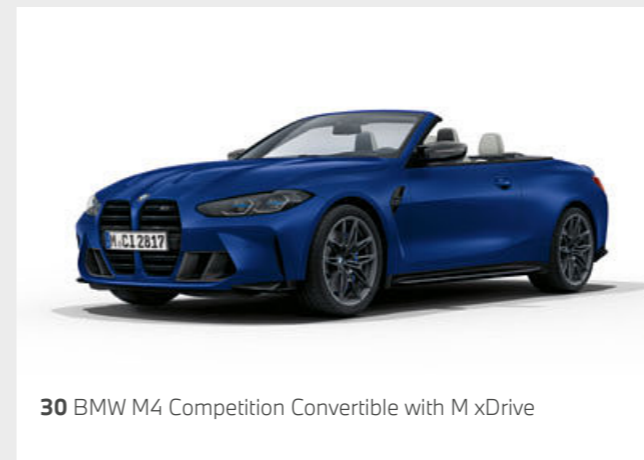

30 BMW M4 Competition Convertible with M xDrive



34 BMW Individual

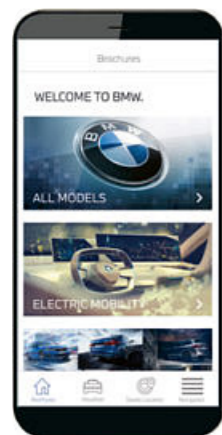

## YOUR BMW BROCHURES APP.

DOWNLOAD NOW THE BMW BROCHURES APP FROM YOUR APP STORE AND DISCOVER DRIVING PLEASURE!



36 Additional equipment



44 Worlds of colour

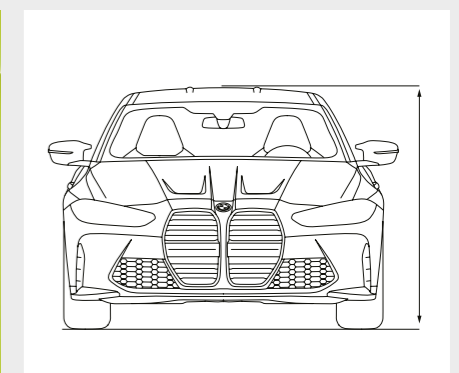

50 Technical data

THE M4 COMPETITION

WARNING:  
MAY CAUSE SENSORY  
OVERLOAD.



DRIFT ON THE EDGE  
OF EUPHORIA.

THE M4 COMPETITION



INSANE INSIDE  
AND OUT.



THE M4 COMPETITION





THE M4 COMPETITION



DIFFERENT METHOD.  
SAME INTENSITY.

THE M3



ALL INSTINCT.  
NOTHING BASIC.



THE M3



DRIVE YOUR  
ADDICTION.

THE M3





# THE NEW STREET DRUG.

THE NEW BMW M4 COMPETITION CONVERTIBLE  
WITH M xDRIVE.



THE M4 COMPETITION CONVERTIBLE



NOT STAND-BY,  
BUT ALL-IN.



THE M4 COMPETITION CONVERTIBLE

■ Standard equipment □ Optional equipment



## ENGINE HIGHLIGHTS OF THE NEW BMW M3 SALOON, NEW BMW M4 COUPÉ, AND NEW BMW M4 CONVERTIBLE WITH M xDRIVE.

### M3 SALOON

BMW M TwinPower Turbo 6-cylinder petrol engine with 353 kW (480 hp) and 550 Nm torque  
 Acceleration 0–100 km/h: 4.2 s  
 Top speed: 250 km/h<sup>3</sup>  
 Combined fuel consumption<sup>1,2</sup>: 10.0-10.2<sup>4</sup> l/100 km  
 Combined carbon dioxide emissions<sup>1,2</sup>: 227-231<sup>4</sup> g/km

### M4 COMPETITION COUPÉ

BMW M TwinPower Turbo 6-cylinder petrol engine with 375 kW (510 hp) and 650 Nm torque  
 Acceleration 0–100 km/h: 3.9 s  
 Top speed: 250 km/h<sup>3</sup>  
 Combined fuel consumption<sup>1,2</sup>: 9.8<sup>4</sup> l/100 km  
 Combined carbon dioxide emissions<sup>1,2</sup>: 223-224<sup>4</sup> g/km

### M4 COMPETITION CONVERTIBLE WITH M xDRIVE

BMW M TwinPower Turbo 6-cylinder petrol engine with 375 kW (510 hp) and 650 Nm torque  
 Acceleration 0–100 km/h: 3.7<sup>4</sup> s  
 Top speed: 250 km/h<sup>3</sup>  
 Combined fuel consumption<sup>1,2</sup>: 10.2<sup>4</sup> l/100 km  
 Combined carbon dioxide emissions<sup>1,2</sup>: 231-233<sup>4</sup> g/km

<sup>1</sup> The figures for performance, fuel consumption and carbon dioxide emissions refer to vehicles with standard transmission.

<sup>1</sup> Performance data of petrol engines apply to vehicles using RON 98 fuel. Fuel consumption data apply to vehicles using reference fuels in accordance with EU Regulation 2007/715. Unleaded RON 91 and higher with a maximum ethanol content of 10% (E10) may also be used. BMW recommends RON 98 super plus unleaded petrol.

<sup>2</sup> Official data for fuel consumption and carbon dioxide emissions was determined in accordance with and complies to the measuring procedures as defined by European Regulation (EU) 715/2007 in the applicable version. In the event of ranges, data determined as per WLTP takes into account any optional equipment (available on the German market in this case). For vehicles that have been newly type approved since 1 January 2021, only the official data according to WLTP exist. For more information about NEDC and WLTP measuring procedures visit [www.bmw.com/wltp](http://www.bmw.com/wltp)

<sup>3</sup> Electronically limited.

□ The **M Driver's Package**<sup>4</sup> increases the top speed to 290 km/h. The M Driver's Package can be ordered when purchasing a new vehicle or can be added on at a later date. All other technical data remain unchanged once installed. A voucher for a one-day BMW M race track training course from BMW Driving Experience is also included.

■ The **M Sport exhaust system** delivers a dynamic sound that can be modified via the integrated exhaust valve mechanism. The SPORT and SPORT+ programmes, which can be selected via the SETUP button, are accentuated by an even more intense engine sound, while the comfort-oriented programme prioritises more discreet engine acoustics.

□ The **M Race Track package** makes the vehicle an uncompromising driver's car for experts. M Carbon ceramic brake, M Carbon bucket seats and M forged wheels reduce weight by up to 25 kg. M Drive Professional, the M Driver's Package and the BMW Head-up display allow perfect control of the increased performance.



<sup>4</sup> The raised top speed is only available after the first service following the 2,000 km run-in period.

Further information on fuel consumption and CO<sub>2</sub> emissions can be found in technical data.

\*The availability of some equipment features and functions depends on engine variants or additional options. The market and production availability may vary. You can find detailed information about terms, standard and optional equipment at [www.bmw.com](http://www.bmw.com) or at your BMW Partner.

■ Standard equipment □ Optional equipment

## MANUAL TRANSMISSION

■ The manual 6-speed M transmission<sup>1</sup> allows for particularly sporty driving characteristics. It is smooth running, perfectly graduated and features precise, short-throw gearshift. The engine's characteristics can be perfectly utilised in terms of power delivery and efficiency by using the most suitable gear.

## ADAPTIVE M SUSPENSION

■ The Adaptive M suspension makes it possible to adjust the damper characteristics to suit any given driving situation, increasing driving dynamics and comfort. In addition to the standard COMFORT setting for increased driving comfort, the SPORT programme offers firmer damper settings, and with SPORT+, the vehicle can be used on the race track.

## STEPTRONIC SPORT TRANSMISSION

■ The 8-speed M Steptronic Sport transmission<sup>2</sup>\* with Drivelogic offers numerous shifting options: extremely dynamic, particularly comfortable and smooth, fuel-saving. You can shift manually using the gear lever or the gearshift paddles on the steering wheel, or select one of three automatic programmes using Drivelogic.

## M SPORT DIFFERENTIAL

■ The Active M Differential optimises traction and driving stability when changing lanes or accelerating out of curves, when making curves at high speeds or on roads with uneven surfaces. Traction is optimised with the help of an electronically operated device that reduces the difference in revolution speed between the rear wheels.

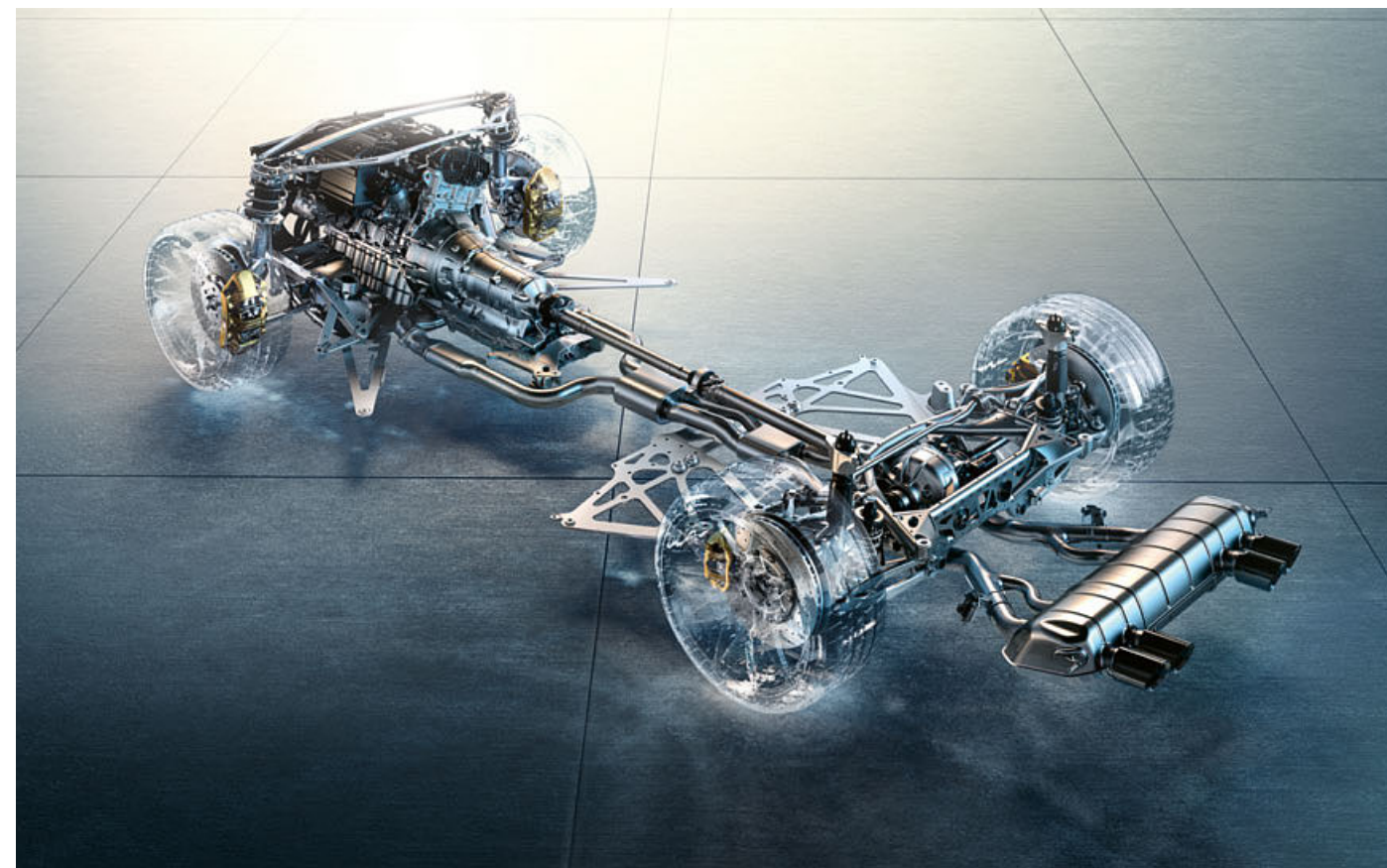

## M xDRIVE

■ With BMW M xDrive<sup>3</sup> and Active M Differential, drivers can experience intensive athletic performance – during everyday driving, as well as at the racetrack. The M specific technology smoothly distributes the drive power variably between the front and rear axle, so that the vehicle reacts with extreme precision and stability, even during dynamic driving and inclement weather conditions, ultimately providing better control. Even the basic settings, with Dynamic Stability Control (DSC) and 4WD turned on, the M characteristic agility is appreciable. With M dynamic mode and 4WD Sport, agility is significantly increased. With DSC off you can choose between

the drive settings 4WD, 4WD Sport and 2WD, depending on personal preference and road conditions. In 2WD mode, ambitious sport drivers get their full money's worth because the drive is distributed only to the rear axle. Only the Active M Differential is in play, variably distributing the drive power between the rear wheels as the situation requires in order to ensure optimal traction and driving stability. All in all, M xDrive heightens the vehicle's driving dynamic qualities, optimises its handling characteristics and makes it easier to control so that you can enjoy the performance even more intensively.



<sup>1</sup> Standard for BMW M3 Saloon and BMW M4 Coupé.

<sup>2</sup> Standard for BMW M3 Competition Saloon, BMW M4 Competition Coupé and BMW M4 Competition Convertible.

<sup>3</sup> Standard for M4 Competition with M xDrive.

\* The availability of some equipment features and functions depends on engine variants or additional options. The market and production availability may vary. You can find detailed information about terms, standard and optional equipment at [www.bmw.com](http://www.bmw.com) or at your BMW Partner.

# CONNECTIVITY AND INFOTAINMENT.

BMW ConnectedDrive  
So connected, you're free.



## BMW OPERATING SYSTEM 7

■ The innovative operating concept of the BMW Operating System 7 enables even easier operation of vehicle functions via e.g. speech, touch screen and iDrive control – very intuitively. For this purpose, the functionality of the Controller has been upgraded. So now the apps menu can be selected directly.

## CONNECTED PACKAGE PROFESSIONAL

□ Concierge Service, Remote Services, smartphone integration incl. Apple CarPlay and Android Auto, In-Car Experiences, Connected Music or BMW Maps with Connected Navigation and Connected Parking? Get them all! With the Connected Package Professional, you can get these BMW ConnectedDrive services as well as BMW Music to test free of charge.

## BMW GESTURE CONTROL

□ With BMW Gesture Control\*, certain functions can be operated by means of defined hand movements. For certain operations the system will for example recognise gestures such as 'swiping' or 'pointing' for accepting or rejecting an incoming call, or circular motions of the index finger to adjust volume.

## SMARTPHONE INTEGRATION

□ Why go without the features of your smartphone in your BMW when you can continue operating it as usual? With smartphone integration<sup>2</sup>, your vehicle supports Apple CarPlay and Android Auto by means of a wireless connection between your smartphone and the vehicle. This allows you to conveniently use familiar functions and various apps in the vehicle.

## BMW DIGITAL KEY

□ No need to take the key with you as long as you have your iPhone with you. You can lock and unlock your BMW and even start it with the BMW Digital Key<sup>1</sup>. You can also authorise up to five people with compatible iPhones to use your BMW. Among other things, the maximum speed can be limited – ideal for novice drivers.

<sup>1</sup> Prerequisite is a BMW ConnectedDrive account and a compatible smartphone. For customers with a non-compatible smartphone, a high-quality Key Card is provided. More information about the BMW Digital Key, e.g. regarding the compatibility of your smartphone, is available at [www.bmw.com/digitalkey](http://www.bmw.com/digitalkey)

<sup>2</sup> Smartphone Integration is permanently available in the vehicle. It includes Apple

CarPlay and Android Auto. Android Auto linking is only possible in conjunction with a BMW Live Cockpit. Due to possible future technical developments (e.g. of mobile phones), the usability of the Apple CarPlay or Google Android Auto service cannot be guaranteed permanently. CarPlay is a trademark of Apple Inc. Android Auto is a trademark of Google LLC.

# DRIVER ASSISTANCE.

■ Standard equipment □ Optional equipment

□ The **Parking Assistant Plus** makes parking and manoeuvring the vehicle easier. It features among others the Surround View system including Top View, Panorama View, Remote 3D View, as well as a lateral parking aid, the emergency braking function Active Park Distance Control, Parking Assistant with longitudinal and lateral guidance and Reversing Assistant.

□ The **Lane Keeping Assistant\*** with active side collision protection supports you up to a speed of 210 km/h with small corrective steering interventions, when the vehicle threatens to leave the lane or to avoid collisions with vehicles on either side. The assistant increases comfort and safety, especially during monotonous driving situations.

□ **Front collision warning with brake intervention\*** actively assists you with the prevention of collisions involving pedestrians and cyclists. It is active at speeds of up to 65 km/h and preconditions the brakes for increased responsiveness. In the event of an emergency, the system prevents a collision or ensures that the collision speed is reduced considerably.

□ **Evasion Assistant\*** supports you during manoeuvres to evade stationary or moving vehicles, cyclists or pedestrians. If a collision is imminent, the possible free space for an evasion manoeuvre is analysed and the steering assistance and the activation of the suspension are used to prevent the collision.

□ The **junction warning with brake intervention\*** detects traffic lights, traffic signs and vehicles crossing and can avoid accidents. If a collision cannot be avoided, the system helps to reduce the impact speed.

□ The **front crossing traffic warning\*** warns you of crossing traffic when entering intersecting crossing traffic in unwieldy places. The system works up to a speed of 7 km/h and can be activated and deactivated via the "Park" setting menu.



\*The availability of some equipment features and functions depends on engine variants or additional options. The market and production availability may vary. You can find detailed information about terms, standard and optional equipment at [www.bmw.com](http://www.bmw.com) or at your BMW Partner.

Some ConnectedDrive Services may differ between countries. Please consult your local BMW partner for more information.

# BMW M3 SALOON.

Discover even more with the new BMW Brochures app. Available now, for your smartphone and tablet.

■ Standard equipment □ Optional equipment



The new BMW M3 Saloon raises the pulse rate from the very first glance and will be remembered for a long time to come. Fresh and contemporary, the luminous Isle of Man Green metallic interprets the classic British Racing Green. M Sport seats guarantee perfect ergonomics and optimum lateral support. In optional full leather trim 'Merino' Kyalami Orange/Black, they give the interior of the new BMW M3 Saloon an extremely powerful and confident appearance.



The clearly painted M carbon roof visually highlights the race-proven design and at the same time lowers the centre of gravity. Fins on the roof tear-off edge and the M rear spoiler, discreetly painted in body colour, optimise the aerodynamics of the new BMW M3 Saloon. The double-flanged twin-flow tailpipes in Chrome high-gloss and the extensively lowered M diffuser trim testify to the built-in racing technology and visually close the rear downwards.



■ The M leather steering wheel with its contoured thumb rests provides a direct, athletic steering experience and maximum control. The integrated multifunction enables the operation of various multimedia and assistance systems. The red M1/M2 buttons can be used to access two preset M Drive configurations.

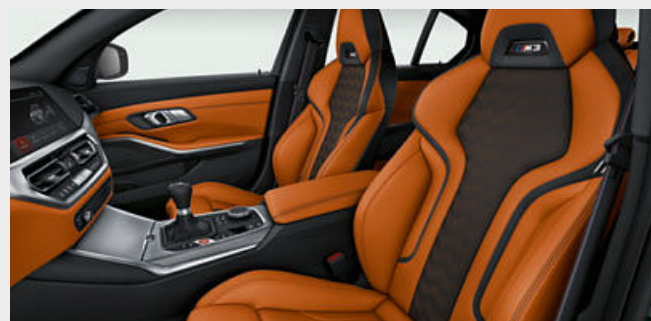

■ The multi-adjustable M Sport seats with bucket seat character and partly integrated headrest provide excellent lateral support for you and your front passenger. In addition, the backrest width can be individually adjusted. Their special design with illuminated M3 logo highlights the vehicle's athletic capabilities.

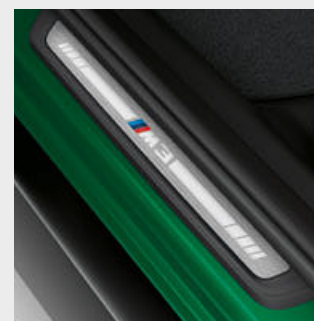

■ The door sill finishers with model designation emphasise the vehicle's sporty character.



□ Thanks to the use of a special material mix, M Compound brakes with brake calipers in Red high-gloss achieve outstanding deceleration values and are extremely stable.

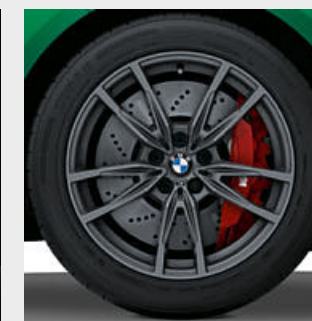

□ 18"/19" M forged wheels Double-spoke style 824 M Orbit Grey with mixed tyres, wheel size front 9.5J x 18 with 275/40 R18 tyres, wheel size rear 10.5J x 19 with 285/35 R19 tyres.

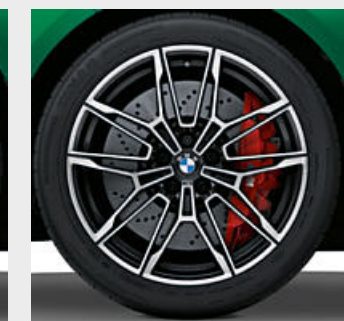

□ 19"/20" M forged wheels Double-spoke style 825 M Bicolour Black with mixed tyres, gloss-lathed/gloss-milled, wheel size front 9.5J x 19 with 275/35 R19 tyres, wheel size rear 10.5J x 20 with 285/30 R20 tyres.

# BMW M4 COMPETITION COUPÉ.

Discover even more with the new BMW Brochures app. Available now, for your smartphone and tablet.

■ Standard equipment □ Optional equipment



Absolute willingness to perform is written all over the new BMW M4 Competition Coupé. The High Gloss Black accents of the BMW Individual high-gloss Shadowline exterior trim with extended features increase the visual intensity of the solid paint finish in Sao Paulo Yellow. Large air inlets cover the high cooling requirements of the high-performance units. Particularly in combination with the M Carbon exterior package, they reinforce the racing character of the new BMW M4 Competition Coupé with their clear paint finish.



The visible fibre structure of the exclusive M carbon roof and M rear spoiler visually stages the elaborate, weight-reduced design.



□ The athletic interior equipment is defined by the classic M driver orientation and perfectly crafted materials. The steering wheel covers and shift paddles of the M leather steering wheel are made of lightweight carbon fibre, as are the M interior trim finishers. The concise M4 Competition inscription indicates the special position of the model.



□ With its low seat position, high side sections, integrated head restraints and cut-outs, the M Carbon bucket seat, shown here in full leather Merino finely structured Yas Marina Blue/Black, gives you a racing car-like seating experience.

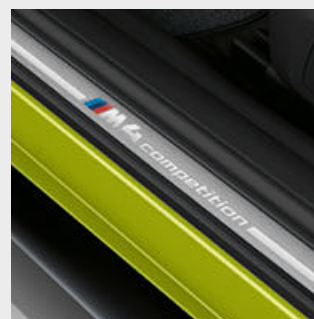

■ Door sill finishers with the "M4 Competition" designation in the front on the left and right.

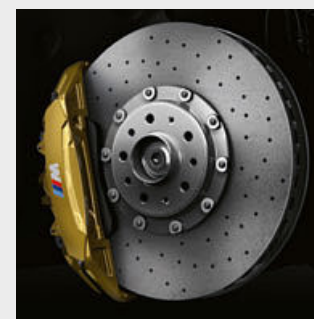

□ The weight-optimised M Carbon ceramic brake<sup>1</sup>\* provides outstanding performance, high thermal resistance and is highly durable.



□ 19"/20" M forged wheels Double-spoke style 826 M Bicolour Black with mixed tyres, Translucent Shadow, wheel size front 9.5J x 19 with 275/35 R19 tyres, wheel size rear 10.5J x 20 with 285/30 R20 tyres.

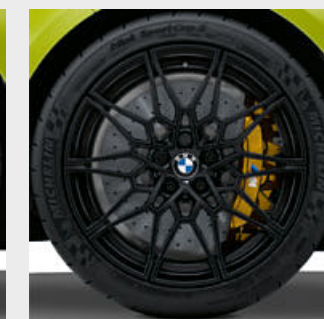

□ 19"/20" M forged wheels Double-spoke style 826 M Black with mixed tyres and track tyres, wheel size front 9.5J x 19 with 275/35 R19 tyres, wheel size rear 10.5J x 20 with 285/30 R20 tyres.

<sup>1</sup> Depending on conditions and usage, features specific to the materials used can lead to operational noises, particularly in wet conditions, just before the vehicle comes to a halt.

\*The availability of some equipment features and functions depends on engine variants or additional options. The market and production availability may vary. You can find detailed information about terms, standard and optional equipment at [www.bmw.com](http://www.bmw.com) or at your BMW Partner.

# BMW M4 COMPETITION CONVERTIBLE WITH M xDRIVE.

Discover even more with the new BMW Brochures app. Available now, for your smartphone and tablet.

■ Standard equipment □ Optional equipment



The new BMW M4 Competition Convertible with M xDrive represents unadulterated driving pleasure with the convertible top down and uncompromising readiness to perform. The BMW Individual high-gloss Shadowline exterior trim with extended features sets visual highlights in the BMW Individual Frozen Portimao Blue metallic paintwork thanks to black high-gloss elements.



With the convertible top down, the wide, confident rear has a particularly athletic effect thanks to the M rear spoiler and the visible M Carbon bucket seats.



□ M interior trim finishers 'Carbon Fibre' with highlight trim finisher Pearl Chrome and carbon-fibre inlay on the steering wheel and shift paddles



□ The M Carbon bucket seat with illuminated M4 logo combines the lightness and racing character of a bucket seat with the range of functions of an M Sport seat. Its contouring offers perfect side support and excellent long distance comfort. It is compatible with multipoint harnesses and therefore fully suitable for racing.

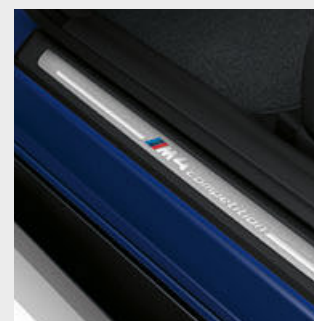

■ Door sill finishers with the "M4 Competition" designation in the front on the left and right.

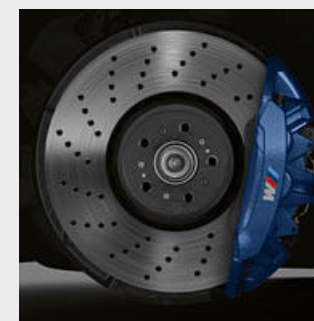

■ Thanks to the use of a special material mix, M Compound brakes with brake calipers in Blue high-gloss achieve outstanding deceleration values and are extremely stable.



□ 19"/20" M forged wheels Double-spoke style 825 M Bicolour Orbit Grey matt with mixed tyres, gloss-lathed rim/rim flange, wheel size front 9.5J x 19 with 275/35 R19 tyres, wheel size rear 10.5J x 20 with 285/30 R20 tyres.



□ 19"/20" M forged wheels Double-spoke style 826 M Bicolour Black with mixed tyres, Translucent Shadow, wheel size front 9.5J x 19 with 275/35 R19 tyres, wheel size rear 10.5J x 20 with 285/30 R20 tyres.

\*The availability of some equipment features and functions depends on engine variants or additional options. The market and production availability may vary. You can find detailed information about terms, standard and optional equipment at [www.bmw.com](http://www.bmw.com) or at your BMW Partner.



# BMW M340i xDRIVE SALOON AND BMW M340d xDRIVE SALOON.

Discover even more with the new BMW Brochures app. Available now, for your smartphone and tablet.



■ The M Leather steering wheel including multifunction buttons, an M badge and an integrated driver-side airbag is featured in three-spoke design. With a steering wheel rim in leather 'Walknappa' Black with black stitching and contoured thumb rests, it provides a direct, athletic steering experience.



■ The Sport seats for driver and front passenger provide optimum lateral support with their raised side bolsters and manually adjustable thigh support. The fore-and-aft position and seat angle can be manually adjusted.



■ 18" M light alloy wheels Double-spoke style 790 M Bicolour Orbit Grey with mixed tyres, gloss-lathed, front 7.5J x 18 with 225/45 R18 tyres, rear 8.5J x 18 with 255/40 R18 tyres.



□ 19" M light alloy wheels Double-spoke style 792 M Bicolour Cerium Grey with performance tyres and mixed tyres, gloss-lathed, front 8J x 19 with 225/40 R19 tyres, rear 8.5J x 19 with 255/35 R19 tyres.

# BMW M440i xDRIVE COUPÉ.

■ Standard equipment □ Optional equipment



■ The M Leather steering wheel including multifunction buttons, an M badge and an integrated driver-side airbag is featured in three-spoke design. With a steering wheel rim in leather 'Walknappa' Black with black stitching and contoured thumb rests, it provides a direct, athletic steering experience.

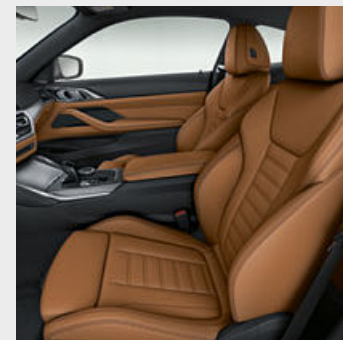

■ The Sport seats for driver and front passenger provide optimum lateral support with their raised side bolsters and manually adjustable thigh support. The fore-and-aft position and seat angle can be manually adjusted.



□ 19" M light alloy wheels Double-spoke style 797 M Bicolour Jet Black matt with mixed tyres and run-flat tyres, gloss-lathed, wheel size front 8J x 19 with 225/40 R19 tyres, wheel size rear 8.5J x 19 with 255/35 R19 tyres.

# BMW M440i xDRIVE CONVERTIBLE.



■ The M Leather steering wheel including multifunction buttons, an M badge and an integrated driver-side airbag is featured in three-spoke design. With a steering wheel rim in leather 'Walknappa' Black with black stitching and contoured thumb rests, it provides a direct, athletic steering experience.

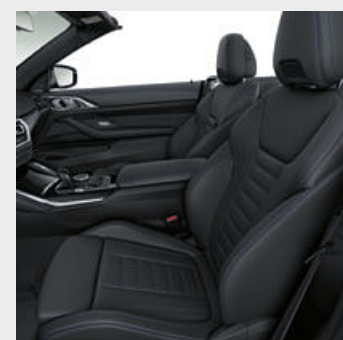

■ The Sport seats for driver and front passenger provide optimum lateral support with their raised side bolsters and manually adjustable thigh support. The fore-and-aft position and seat angle can be manually adjusted.



□ 19" M light alloy wheels Double-spoke style 791 M Jet Black uni with performance tyres and mixed tyres, wheel size front 8J x 19 with 225/40 R19 tyres, wheel size rear 8.5J x 19 with 255/35 R19 tyres.

\*The availability of some equipment features and functions depends on engine variants or additional options. The market and production availability may vary. You can find detailed information about terms, standard and optional equipment at [www.bmw.com](http://www.bmw.com) or at your BMW Partner.

# BMW INDIVIDUAL.

THE EXPRESSION OF PERSONALITY.



Applied with the highest level of craftsmanship, the exclusive BMW Individual Matt paint finishes stand out from the crowd with their silky shimmer. Special pigmentation within the multi-coat painting process allows each line, each surface to develop its highest expressive power - as for example in the BMW Individual paint finish Frozen Brilliant White metallic.



BMW Individual full leather trim 'Merino' VBTQ Tartufo with partial perforation



BMW Individual interior trim finishers piano finish Black with highlight trim finisher Pearl Chrome



BMW Individual full leather trim 'Merino' ZBFV Fjord Blue/Black with partial perforation



M interior trim finishers 'Carbon Fibre' with highlight trim finisher Pearl Chrome and carbon-fibre inlay on the steering wheel and shift paddles



BMW Individual full leather trim 'Merino' VBHZ Fiona Red/Black with partial perforation



M interior trim finishers 'Carbon Fibre' with highlight trim finisher Pearl Chrome and carbon-fibre inlay on the steering wheel and shift paddles

If someone decides, then you: BMW Individual offers you every opportunity to design the new BMW M3 Saloon, the new BMW M4 Coupé and the new BMW M4 Competition Convertible with M xDrive to suit your individual wishes, leaving the degree of customisation entirely up to you. Add your personal driving experience to the typical BMW driving pleasure. Choose what suits you the most from particularly

high-quality equipment options: Exclusive BMW Individual paintwork that show style and confidence. Soft, voluminous leather trims and interior trim finishers made of fine woods, which turn the interior into your personal comfort zone. Or go your very own way, only following your ideas – BMW Individual ensures that they will become an automotive reality.

# ADDITIONAL EQUIPMENT.

Discover even more with the new BMW Brochures app. Available now, for your smartphone and tablet.

■ Standard equipment □ Optional equipment



□ The BMW Individual Composition gives the vehicle a particularly elegant and unique character. The BMW Individual paintwork contributes to this, as do the BMW Individual interior trim finishers and the BMW Individual full leather trim 'Merino'.



□ The M Carbon exterior package underlines the athletic demands of the vehicle. Spoiler elements in the front bumper and exterior mirror caps are made of carbon-fibre reinforced plastic (CFRP). The package is rounded off by a striking carbon-fibre diffuser insert at the rear.



□ The M lights Shadow Line include a black finish of all chrome elements in the headlights, creating an unmistakable design.



□ The M high-gloss Shadow Line with extended contents\* includes specific equipment features in Black: Exterior mirror caps in Black high-gloss and tailpipe trims in Black Chrome.



□ The air conduction elements in the bumper, which are made of carbon, make the vehicle's motorsport DNA shine even brighter. This lightweight element forms two distinctive channels for the cooling air and creates an expressive accent in the front apron.



□ Aerodynamically optimised M exterior mirrors reduce the drag of the new BMW M4 Coupé. The mirror caps made of visible carbon bring this constructive fine-tuning into focus visually as well.



■ The M high-gloss Shadow Line includes numerous equipment features in Black high-gloss. These include the window cavity seals including the softtop finishers, the exterior mirror frame and the mirror triangle and blade.



□ The M headliner in anthracite lends the sporty ambience even more exclusivity and an exceptional feel.



□ The M Carbon rear spoiler\* enhances the visual dynamics of the rear. As an exclusive and concise accent, it makes the adrenaline-charged racing DNA of the new BMW M4 Coupé visible at first glance.



□ The high-quality rear diffuser made of carbon emphasises the vehicle's high-tech nature and adds an even sportier note. It is made of the lightweight material carbon, which has been elaborately handcrafted and has its origins in motorsport. The striking design with its pronounced struts embodies maximum performance.

\*The availability of some equipment features and functions depends on engine variants or additional options. The market and production availability may vary. You can find detailed information about terms, standard and optional equipment at [www.bmw.com](http://www.bmw.com) or at your BMW Partner.

# ADDITIONAL EQUIPMENT.

Discover even more with the new BMW Brochures app. Available now, for your smartphone and tablet.

■ Standard equipment □ Optional equipment



□ 19"/20" M forged wheels Double-spoke style 826 M Black with mixed tyres and track tyres, wheel size front 9.5J x 19 with 275/35 R19 tyres, wheel size rear 10.5J x 20 with 285/30 R20 tyres.<sup>1,2</sup>



■ As part of BMW's intelligent lightweight construction, the carbon roof<sup>4</sup> made of carbon fibre reinforced plastic (CFRP) helps to reduce the car's mass, and shifts the car's centre of gravity lower. This leads to an increase in agility and dynamics when taking a bend, accelerating and braking.



■ Thanks to the use of various materials, M Compound brakes achieve outstanding deceleration values, are extremely stable and weigh less. The brake calipers in Blue high-gloss with M lettering lend this high-performance brake system a distinctly sporty appearance.

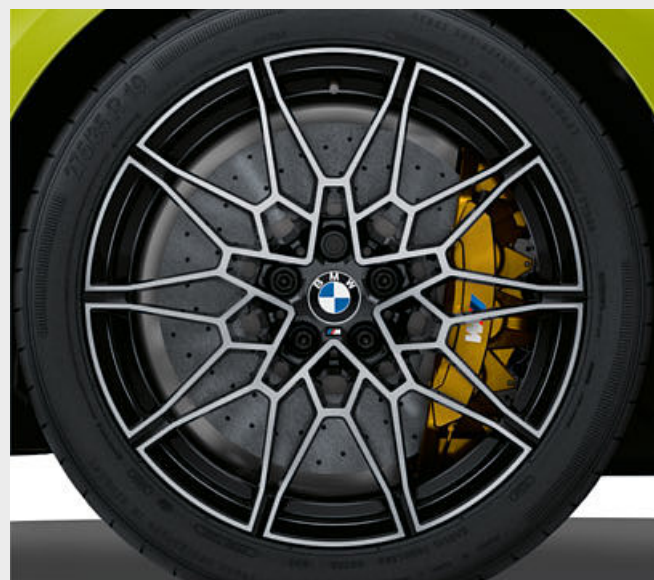

□ 19"/20" M forged wheels Double-spoke style 826 M Bicolour Black with mixed tyres, Translucent Shadow, wheel size front 9.5J x 19 with 275/35 R19 tyres, wheel size rear 10.5J x 20 with 285/30 R20 tyres.<sup>3</sup>



□ 19"/20" M forged wheels Double-spoke style 825 M Bicolour Orbit Grey matt with mixed tyres, gloss-lathed rim/rim flange, wheel size front 9.5J x 19 with 275/35 R19 tyres, wheel size rear 10.5J x 20 with 285/30 R20 tyres.



□ The glass sunroof with slide and lift function, including an electric sliding interior roof, anti-trap protection, as well as comfort opening and closing, allows the airflow to be individually regulated to create a pleasant interior climate. The integrated wind deflector prevents draughts from developing in the interior and ensures a lower level of wind noise.



□ The sun protection glazing prevents the interior from heating up when exposed to direct sunlight. The darker glazing behind the B-pillars absorbs more sunlight. The tinted glazing does not hinder outward visibility, but offers more privacy in the rear.



□ 19"/20" M forged wheels Double-spoke style 825 M Bicolour Black with mixed tyres, gloss-lathed/gloss-milled, wheel size front 9.5J x 19 with 275/35 R19 tyres, wheel size rear 10.5J x 20 with 285/30 R20 tyres.



■ 18"/19" M forged wheels Double-spoke style 824 M Orbit Grey with mixed tyres, wheel size front 9.5J x 18 with 275/40 R18 tyres, wheel size rear 10.5J x 19 with 285/35 R19 tyres.



□ In Laser high-beam mode, the Adaptive BMW Laserlight illuminates a range of up to 550 m, nearly twice as far as that of conventional headlights. Better visibility in the dark significantly increases safety. Blue accents and the lettering "BMW Laser" in the headlight also underline the technological standards and the sportiness of the vehicle.



□ The interior mirror and driver-side exterior mirror feature the automatic anti-dazzle function. Additionally, the front passenger exterior mirror features the automatic parking function when the vehicle is put in reverse. Both exterior mirrors are equipped with an electric fold-in function, as well as a mirror memory function. That makes parking easier and helps to avoid damage to the vehicle.

<sup>1</sup> Also available without track tyres.

<sup>2</sup> The driving dynamics properties of the track tyres vary depending on weather influences and road surface.

<sup>3</sup> Also available with track tyres.

<sup>4</sup> Only available for Saloon and Coupé.

\*The availability of some equipment features and functions depends on engine variants or additional options. The market and production availability may vary. You can find detailed information about terms, standard and optional equipment at [www.bmw.com](http://www.bmw.com) or at your BMW Partner.

# ADDITIONAL EQUIPMENT.

Discover even more with the new BMW Brochures app. Available now, for your smartphone and tablet.

■ Standard equipment □ Optional equipment



■ The multi-adjustable M Sport seats with bucket seat character and partly integrated headrest provide excellent lateral support for you and your front passenger. In addition, the backrest width can be individually adjusted. Their special design with illuminated M4 logo highlights the vehicle's athletic capabilities.



■ The M leather steering wheel with its contoured thumb rests provides a direct, athletic steering experience and maximum control. The integrated multifunction enables the operation of various multimedia and assistance systems. The red M1/M2 buttons can be used to access two preset M Drive configurations.



□ The BMW Live Cockpit Professional with navigation function includes two high-quality displays consisting of a high-resolution 10.25" Control Display that can be operated by touch and a fully digital 12.3" instrument display. The BMW Operating System 7 can also be operated via the iDrive Touch Controller.



□ The M seat belts boast an exquisite woven highlight in the classic M colours and emphasise the extremely high-quality and sporty ambience in the interior.



□ The M Carbon bucket seat with illuminated M4 logo combines the lightness and racing character of a bucket seat with the range of functions of an M Sport seat. Its contouring offers perfect side support and excellent long distance comfort. It is compatible with multipoint harnesses and therefore fully suitable for racing.



□ Driving Assistant Professional offers optimum comfort and safety during critical or monotonous traffic situations. Apart from the contents of the Driving Assistant, it also includes Steering and Lane Control Assistant with extended functions, Emergency Stop Assistant and Lane Keeping Assistant with active side collision protection.<sup>1</sup>



□ The M Setup allows you to configure various driving dynamics parameters such as engine, transmission and steering characteristics, damper settings, Dynamic Stability Control (DSC) control intensity or the power distribution of the M xDrive all-wheel-drive system according to your personal requirements.



□ The anthracite softtop with silver effect blends harmoniously into the dynamic lines of the vehicle. At the push of a button, it opens and closes electrically in approximately 18 seconds, even while driving at speeds of up to 50 km/h. One of the outstanding properties of this high-quality softtop is its excellent noise insulation.



□ Exclusive galvanic embellishers on control elements for power windows, the door control panel and the door lock switch create a high-quality impression.



□ The full-colour BMW Head-Up Display with M specific functions projects information relevant for the journey directly into your field of vision. With the press of a button, you can switch to the M specific display, which includes a gear indicator, the rpm as a dynamic range curve with shift lights indicating the optimal moment to shift as well as navigation tips.<sup>2</sup>



□ Whether track day or spontaneous drift session – M Drive Professional is the perfect companion for trips with that extra portion of adrenaline. The M Laptimer and the M Drift Analyser help you to hunt for best times and the perfect drift angle, while the M TRACK Mode and the ten-step M Traction Control allow for tailor-made drivability.

<sup>1</sup> Function may be limited in darkness, fog or bright glare.

<sup>2</sup> The information in the BMW Head-Up Display is not fully visible when viewed through polarised sunglasses. Content shown will depend on the equipment options chosen. Further optional equipment is required to display specific items.

\*The availability of some equipment features and functions depends on engine variants or additional options. The market and production availability may vary. You can find detailed information about terms, standard and optional equipment at [www.bmw.com](http://www.bmw.com) or at your BMW Partner.

# ADDITIONAL EQUIPMENT.

Discover even more with the new BMW Brochures app. Available now, for your smartphone and tablet.

■ Standard equipment □ Optional equipment



□ The tonally outstanding Harman Kardon surround sound system features a 408 W digital amplifier, nine channels and 12 speakers. Its sophisticated sound perfectly fills the interior space. Vehicle-specific, speed-dependent equalising precisely compensates for any background driving noise.



□ Telephony with wireless charging<sup>1</sup> incorporates a wireless charging dock and a second microphone for a better hands-free voice quality for you and your front passenger. An additional aerial connection improves mobile reception. Two mobile telephones and an audio player can be connected simultaneously via Bluetooth. Also included is the technical capacity for a Wi-Fi hotspot.<sup>1,2</sup>



■ The Automatic air conditioning with 3-zone control and automatic temperature control features separate controls for you and your front passenger, as well as for the passengers in the rear. It also includes Automatic Air Recirculation (AAR), a micro active carbon filter, a fog and solar sensor, as well as rear air vents with a digital display.



□ The dynamically designed high-quality BMW Display Key with M logo shows various status data of the vehicle on the integrated touch display and allows even the operation of selected functions.



□ The Comfort Access makes it possible to open all of the vehicle doors and the luggage compartment, without using the key. When approaching, the welcome greeting is activated even before the doors unlock automatically. You can additionally set up a BMW Digital Key<sup>3</sup> on an iPhone – if compatible – or use the Key Card for accessing and starting the vehicle.<sup>2</sup>



■ Ambient light, including Ambient contour lighting in the front and rear doors, creates a relaxed, cosy lighting atmosphere in the interior. The eleven dimmable lighting designs also include a dynamic function in four applications.



□ In warm weather, the active seat ventilation in the front seats provides more seating comfort. Fans in the backrests and fans in the seats blow interior air at a selectable intensity through the finely perforated seat covers and ensure a comfortable seat temperature for you and your front passenger.<sup>4</sup>



□ The wind deflector provides you and your front passenger with effective protection from draughts at neck and shoulder-height, even when travelling at high speeds. When it is not needed, the collapsible sides can simply be folded together for easy and compact storage.



■ The through-loading system includes rear seat backrests that can be divided in a 40:20:40 ratio for the greatest possible flexibility. For example, two passengers can be seated comfortably in the rear, while long objects such as ski and snowboard bags can be transported at the same time. The two cupholders in the centre armrest are very practical.



□ The seat heating increases the temperature of the seat and backrest surfaces of the front seats as well as the exterior rear seats. It can be individually regulated to three levels for each seat. Even before the engine has reached running temperature, the seat heating provides cosy warmth even in the coldest exterior temperatures – and all that at the push of a button.<sup>5</sup>



□ The neck warmer ensures comfort when driving by pleasantly providing warmth for the head and shoulders. When the roof is open, the warming system integrated into the front seat headrests is automatically regulated based on the speed and outside temperature. Three different temperature levels can also be personally selected.

<sup>1</sup> Supports inductive charging for Qi-compatible mobile phones. Special charging cases are available from Original BMW Accessories for selected smartphones that do not support the Qi standard for inductive charging.

<sup>2</sup> The WiFi hotspot fulfils all in-vehicle requirements for use of the internet with the maximum LTE standard. Usage is subject to cost.

<sup>3</sup> Prerequisite is a BMW ConnectedDrive account and a compatible smartphone. For customers with a non-compatible smartphone, a high-quality Key Card is provided. More information about the BMW Digital Key, e.g. regarding the compatibility of your smartphone, is available at [www.bmw.com/digitalkey](http://www.bmw.com/digitalkey)

<sup>4</sup> Not in conjunction with M Carbon bucket seat.

<sup>5</sup> Only available for M3 Saloon / Competition Saloon. The availability of some equipment features and functions depends on engine variants or additional options. The market and production availability may vary. You can find detailed information about terms, standard and optional equipment at [www.bmw.com](http://www.bmw.com) or at your BMW Partner.

# EXTERIOR COLOUR WORLD.

Discover even more with the new BMW Brochures app. Available now, for your smartphone and tablet.

■ Standard equipment □ Optional equipment



■ Non-metallic 300 Alpine White

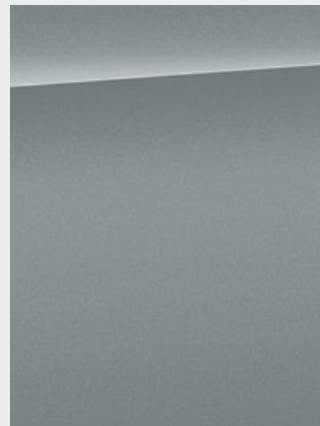

□ Metallic C4P M Brooklyn Grey

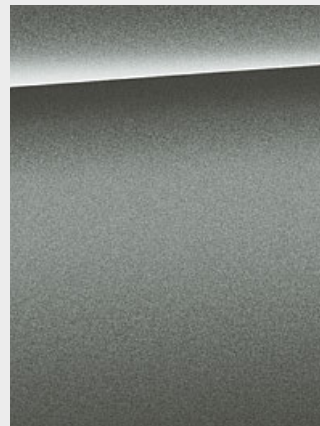

□ Metallic C4W Skyscraper Grey



□ Metallic 475 Black Sapphire



□ Solid paint C4H M Sao Paulo Yellow



□ Metallic C4G M Isle of Man Green



□ Metallic C31 M Portimao Blue

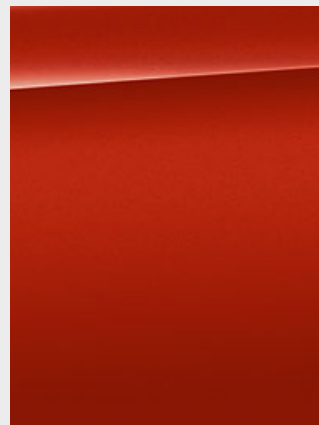

□ Metallic C3G M Toronto Red

## BMW INDIVIDUAL



□ BMW Individual X16 Frozen Brilliant White metallic



□ BMW Individual special pointwork Frozen Dark Grey metallic<sup>1</sup>

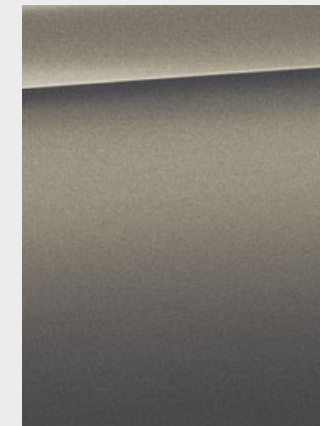

□ BMW Individual C4A Oxide Grey metallic<sup>2</sup>

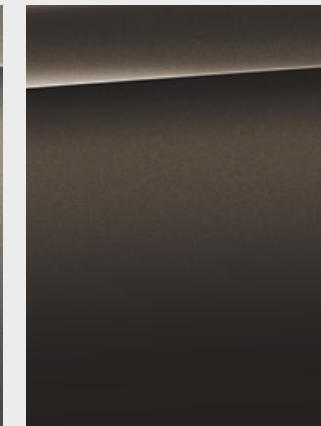

□ BMW Individual C36 Dravit Grey metallic



□ BMW Individual special pointwork Frozen Deep Grey metallic<sup>2</sup>

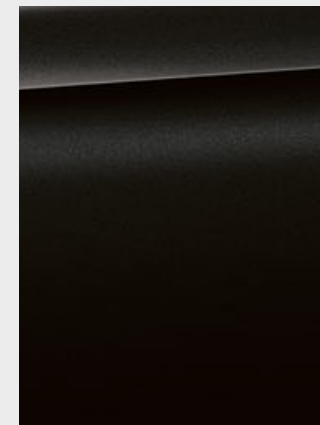

□ BMW Individual special pointwork Frozen Black metallic

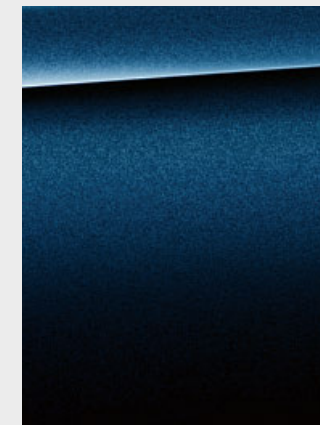

□ BMW Individual C3Z Tanzanite Blue metallic



□ BMW Individual X1E Frozen Portimao Blue metallic

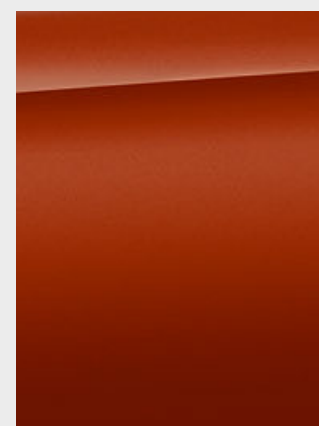

□ BMW Individual special pointwork Frozen Orange metallic

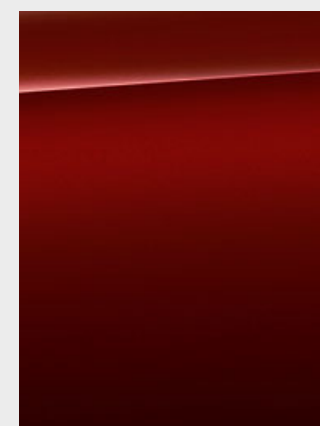

□ BMW Individual C57 Aventurine Red metallic<sup>3</sup>

**[Colour samples]** These colour samples are intended as an initial guide to the colours and materials available for your BMW. However, experience has shown that printed versions of paint, upholstery and interior trim colours cannot in all cases faithfully

reproduce the appearance of the original colour. Please discuss your preferred colour choices with your BMW partner or in your dealership. There you can also see original samples and be assisted with special requests.

<sup>1</sup> Only available for M3 and M3 Competition.  
<sup>2</sup> Only available for M4 and M4 Competition.  
<sup>3</sup> Available from 07/2021.

The availability of some equipment features and functions depends on engine variants or additional options. The market and production availability may vary. You can find detailed information about terms, standard and optional equipment at [www.bmw.com](http://www.bmw.com) or at your BMW Partner.

Discover even more with the new BMW Brochures app. Available now, for your smartphone and tablet.

■ Standard equipment □ Optional equipment

## LEATHER M SPORT SEATS

■ Leather 'Merino' LKSW with extended contents Black with contrast in Black Grey and Grey	□ Leather 'Merino' LKIA with extended contents Silverstone/Black with contrast in Black Grey and Grey	□ Leather 'Merino' LKG5 with extended contents Yas Marina Blue/Black with contrast in Yellow	□ Leather 'Merino' LKKX with extended contents Kyalami Orange/Black with contrast in Black Grey and Black
□ Full leather 'Merino' X3SW Black with contrast in Black Grey and Grey*	□ Full leather 'Merino' X3IA Silverstone with contrast in Black Grey and Grey*	□ Full leather 'Merino' X3G5 Yas Marina Blue with contrast in Yellow*	□ Full leather 'Merino' X3KX Kyalami Orange with contrast in Black Grey and Black*

## LEATHER M CARBON BUCKET SEATS

■ Leather 'Merino' LKSW with extended contents Black with contrast in Black Grey and Grey*	□ Leather 'Merino' LKIA with extended contents Silverstone/Black with contrast in Black Grey and Grey*	□ Leather 'Merino' LKG5 with extended contents Yas Marina Blue/Black with contrast in Yellow*	□ Leather 'Merino' LKKX with extended contents Kyalami Orange/Black with contrast in Black Grey and Black*
□ Full leather 'Merino' X3SW Black with contrast in Black Grey and Grey*	□ Full leather 'Merino' X3IA Silverstone with contrast in Black Grey and Grey*	□ Full leather 'Merino' X3G5 Yas Marina Blue with contrast in Yellow*	□ Full leather 'Merino' X3KX Kyalami Orange with contrast in Black Grey and Black*

## INTERIOR TRIM FINISHERS

■ Interior trim finishers Black high-gloss with highlight trim finisher in Pearl Chrome	□ M interior trim finishers 'Carbon Fibre' with highlight trim finisher Pearl Chrome <sup>1</sup>	□ M interior trim finishers Aluminium Tetrakon with highlight trim finisher Pearl Chrome

## BMW INDIVIDUAL LEATHER

□ BMW Individual extended leather trim 'Merino' ZAEW Ivory White	□ BMW Individual extended leather trim 'Merino' VATQ Tartufo <sup>2</sup> *	□ BMW Individual extended leather trim 'Merino' VAHZ Fiona Red/Black*	□ BMW Individual extended leather trim 'Merino' ZAFV Fjord Blue/Black
□ BMW Individual full leather trim 'Merino' ZBEW Ivory White	□ BMW Individual full leather trim 'Merino' VBTQ Tartufo <sup>2</sup> *	□ BMW Individual full leather trim 'Merino' VBHZ Fiona Red/Black*	□ BMW Individual full leather trim 'Merino' ZBFV Fjord Blue/Black

## BMW INDIVIDUAL INTERIOR TRIM FINISHERS

□ BMW Individual interior trim finishers piano finish Black with highlight trim finisher Pearl Chrome	□ BMW Individual fine-wood trim 'Fineline' Black with silver effect open-pored and highlight trim finisher in Pearl Chrome	□ BMW Individual interior trim finishers Aluminium fabric high-gloss with highlight trim finisher in Pearl Chrome

Please note that even normal long- or short-term use can lead to unrecoverable upholstery damage. This can be caused in particular by non-colourfast clothing. Please note that the interior colour depends on the selected upholstery colour.

<sup>1</sup> Also includes steering wheel trims and – for BMW M3 Competition and BMW M4 Competition – gearshift paddles in carbon fibre.

<sup>2</sup> Not in conjunction with M Carbon bucket seats.

\*The availability of some equipment features and functions depends on engine variants or additional options. The market and production availability may vary. You can find detailed information about terms, standard and optional equipment at [www.bmw.com](http://www.bmw.com) or at your BMW Partner.



# M PERFORMANCE PARTS.

Discover even more with the new BMW Brochures app. Available now, for your smartphone and tablet.

o Accessories



The BMW M3 and BMW M4 bring high-performance sport to the road. Numerous technologies derived from motorsport offer maximum performance and dynamics in perfection - in every driving situation. The breathtaking motorsport feeling is rounded off by the exclusive, tailor-made BMW M Performance Parts in unique carbon look. The interplay creates a vehicle that releases adrenaline at every moment and draws all attention to itself. Give your BMW maximum individuality and genuine racing character with BMW M Performance Parts, with a wide range of products available in the areas of aerodynamics, drive, exterior design, cockpit, chassis, and wheels.



o 19"/20" M Performance forged wheels Y-spoke style 963 M for vehicles with central locking in Jet Black matt. Summer complete wheel set with tyre pressure monitor.

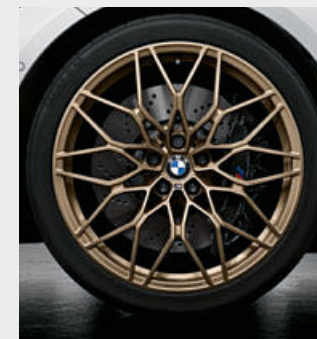

o 20"/21" M Performance Forged Wheels Cross-spoke style 1000 M in Gold Bronze. Complete summer wheel set with tyres featuring tyre pressure monitor.



o Perfectly well-rounded, with stunning corners and angles: the M Performance steering wheel Pro creates an unmistakable motorsport atmosphere in the cockpit. It inspires with its striking form and very pronounced grip area made of Alcantara – for a more direct steering feel. With a motorsport mark in light blue leather.



o Make a strong statement: The M Performance front splitter made from 100 percent carbon fibre highlights the vehicle's masculine appearance in a highly exclusive manner. A unique motorsport look for anybody who refuses to compromise.



o Breathtaking for the ears: The M Performance exhaust system fascinates with an uncompromising motorsport sound. The silencer and the sporty tailpipe module are made entirely in race-grade titanium.



o The M Performance rear diffuser from carbon fibre impressively underlines the vehicle's athletic appearance.

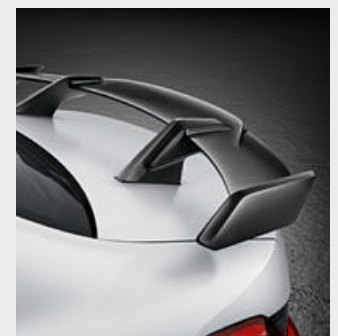

o The M Performance rear spoiler with aerodynamic cut-out is made from 100 percent high-quality carbon fibre and creates a distinctive motorsport look at the rear of the vehicle.

Discover the wide range of innovative solutions available for the exterior and interior, communication and information, and for transportation and the luggage compartment. Your BMW Partner is on hand to advise you on the whole range of Original BMW Accessories and the BMW M Performance Parts product portfolio. For further information, please visit [www.bmw.com](http://www.bmw.com)

The availability of some equipment features and functions depends on engine variants or additional options. The market and production availability may vary. You can find detailed information about terms, standard and optional equipment at [www.bmw.com](http://www.bmw.com) or at your BMW Partner.

Discover even more with the new BMW Brochures app. Available now, for your smartphone and tablet.

		M3 Saloon	M3 Competition Saloon	M3 Competition M xDrive Saloon	M4 Coupé	M4 Competition Coupé	M4 Competition M xDrive Coupé	M4 Competition Convertible with M xDrive
<b>Weight</b>								
Unladen weight EU <sup>1</sup>	kg	1780	1805	1855	1775	1800	1850	1995
Maximum permissible weight	kg	2210	2210	2260	2155	2155	2205	2345
Permitted load	kg	505	480	480	455	430	430	425
Luggage capacity	l	480	480	480	440	440	440	385–300
<b>BMW M TwinPower Turbo engine<sup>2</sup></b>								
Cylinders/valves	–	6/4	6/4	6/4	6/4	6/4	6/4	6/4
Capacity	cm <sup>3</sup>	2993	2993	2993	2993	2993	2993	2993
Max. output/ engine speed	kW (hp)/ rpm	353 (480)/ 6250	375 (510)/ 6250	375 (510)/ 6250	353 (480)/ 6250	375 (510)/ 6250	375 (510)/ 6250	375 (510)/ 6250
Max. torque/ engine speed	Nm/ rpm	550/ 2650–6130	650/ 2750–5500	650/ 2750–5500	550/ 2650–6130	650/ 2750–5500	650/ 2750–5500	650/ 2750–5500
<b>Power transmission</b>								
Type of drive	–	Rear-wheel	Rear-wheel	M xDrive	Rear-wheel	Rear-wheel	M xDrive	M xDrive
Standard transmission	–	Manual transmission	M Steptronic transmission	M Steptronic transmission	Manual transmission	M Steptronic transmission	M Steptronic transmission	M Steptronic transmission
<b>Performance</b>								
Top speed <sup>4</sup>	km/h	250	250	250	250	250	250	250
Top speed with optional M Driver's Package <sup>4,5</sup>	km/h	290	290	290	290	290	290	280
Acceleration 0–100 km/h	s	4.2	3.9	3.5	4.2	3.9	3.5	3.7
<b>Consumption<sup>2,3</sup>– All engines conform to the EU6 standard</b>								
Low	l/100 km	14.8–15.5	15.1–15.2	15.5–15.6	14.7–15.4	15.1–15.2	15.5–15.6	15.3
Medium	l/100 km	9.8–10.0	9.9	10.0–10.1	9.7–10.0	9.9	10.0–10.1	10.2–10.3
High	l/100 km	8.5–8.6	8.4	8.5–8.7	8.5–8.6	8.4	8.5–8.6	8.7–8.8
Maximum value	l/100 km	9.5–9.6	9.0	9.3–9.5	9.5–9.6	9.0	9.2–9.4	9.4–9.6
Combined	l/100 km	10.0–10.2	9.8	10.0–10.1	9.9–10.1	9.8	10.0–10.1	10.2
Exhaust emissions standard (type-certified)	–	EU6d	EU6d	EU6d	EU6d	EU6d	EU6d	EU6d
Combined CO <sub>2</sub> emissions	g/km	227–231	223–224	228–231	226–230	223–224	227–230	231–233
Tank capacity, approx.	l	59	59	59	59	59	59	59
<b>Wheels/tyres</b>								
Tyre size	–	275/40 R18 Y 285/35 R19 Y	275/40 R18 Y 285/35 R19 Y	275/35 R19 Y 285/30 R20 Y	275/40 R18 Y 285/35 R19 Y	275/40 R18 Y 285/35 R19 Y	275/35 R19 Y 285/30 R20 Y	275/35 R19 Y 285/30 R20 Y
Wheel size	–	9.5J x 18 10.5J x 19	9.5J x 18 10.5J x 19	9.5J x 19 10.5J x 20	9.5J x 18 10.5J x 19	9.5J x 18 10.5J x 19	9.5J x 19 10.5J x 20	9.5J x 19 10.5J x 20
Material	–	Light alloy	Light alloy	Light alloy	Light alloy	Light alloy	Light alloy	Light alloy

## BMW M3 Saloon

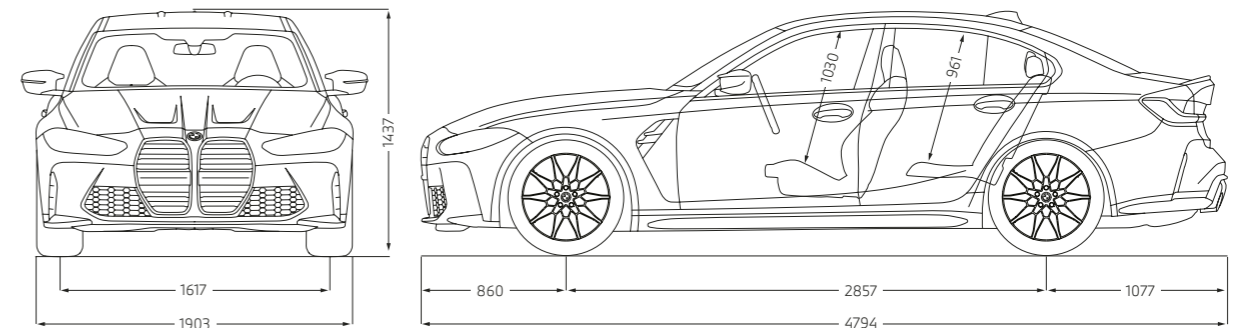

## BMW M4 Coupé

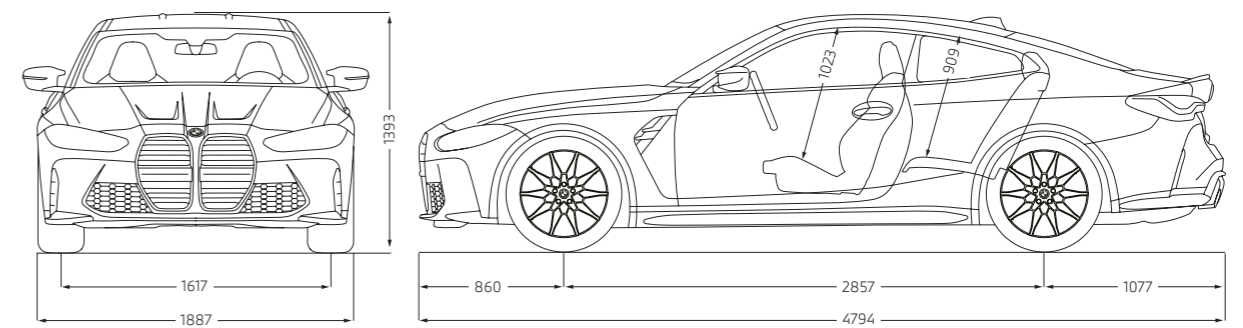

## BMW M4 Competition Convertible with M xDrive

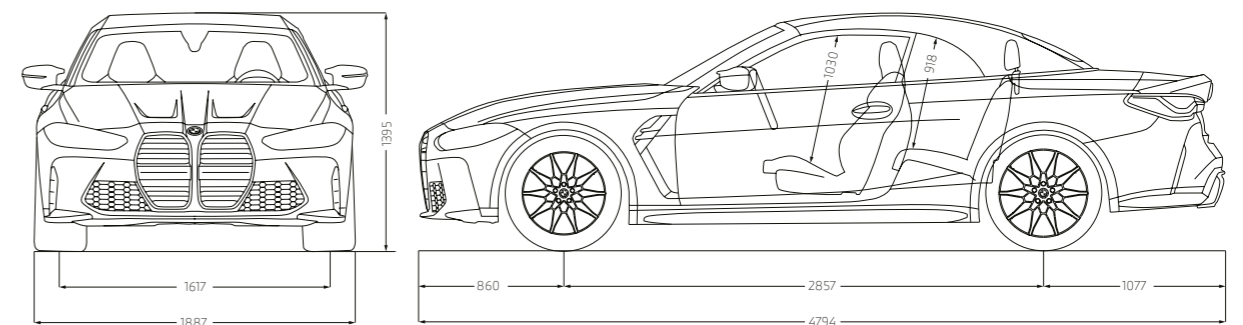

All dimensions in the technical drawing are given in millimetres. The figures for performance, fuel consumption and CO<sub>2</sub> emissions refer to vehicles with standard transmission.

<sup>1</sup> The EC unladen weight refers to a vehicle with standard equipment and does not include any optional extras. The unladen weight includes a 90% full tank and a driver weight of 75 kg. Optional equipment may affect the weight of the vehicle, the payload and the top speed if the selected equipment has an impact on the vehicle's aerodynamics.

<sup>2</sup> Performance data of petrol engines apply to vehicles using RON 98 fuel. Fuel consumption data apply to vehicles using reference fuels in accordance with EU Regulation 2007/715. Unleaded RON 91 and higher with a maximum ethanol content of 10% (E10) may also be used. BMW recommends RON 98 super plus unleaded petrol.

<sup>3</sup> Official data for fuel consumption and carbon dioxide emissions was determined in accordance with and complies to the measuring procedures as defined by European Regulation (EU) 715/2007 in the applicable version. In the event of ranges, data determined as per WLTP takes into account any optional equipment (available on the German market in this case). For vehicles that have been newly type approved since 1 January 2021, only the official data according to WLTP exist. For more information about NEDC and WLTP measuring procedures visit [www.bmw.com/wltp](http://www.bmw.com/wltp)

<sup>4</sup> Electronically limited.

<sup>5</sup> The raised top speed is only available after the first service following the 2,000 km run-in period.

# THE 3

THE X1

THE X6 M

THE X4

THE M4



THE 6

THE 2

THE X7

THE 8

THE 4

THE 1

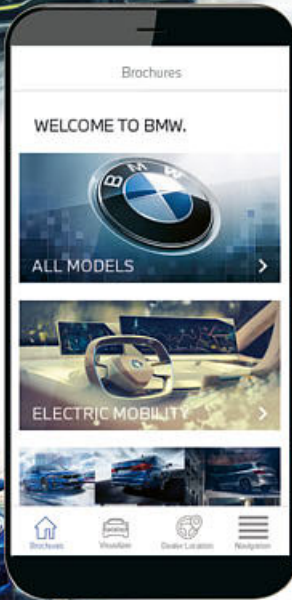

THE Z4



THE M3

THE 7

THE M5

THE 5

THE iX3

THE M8

THE X2



## YOUR NEW SPEED DATING APP.

DOWNLOAD NOW THE BMW BROCHURES APP FROM YOUR APP STORE AND DISCOVER DRIVING PLEASURE!

### BMW M3 SALOON:

BMW M TwinPower Turbo 6-cylinder petrol engine, 353 kW (480 hp), 19"/20" M forged wheels Double-spoke style 825 M Bicolour Black with mixed tyres, exterior paintwork in Isle of Man Green metallic, BMW Laserlight, M Sport seats in full leather Merino finely structured Kyalami Orange/Black, BMW Individual interior trim finishers in Aluminium fabric high-gloss.

### BMW M4 COMPETITION COUPÉ:

BMW M TwinPower Turbo 6-cylinder petrol engine, 375 kW (510 hp), 19"/20" M Forged Wheels, Double-spoke 826 M Black with mixed tyres with run-flat tyres, exterior paintwork in Sao Paulo yellow, BMW Laserlight, M Carbon bucket seats in full leather 'Merino' finely structured Yas Marina Blue/Black, Carbon Fibre M interior trim.

### BMW M4 COMPETITION CONVERTIBLE WITH M xDRIVE:

BMW M TwinPower Turbo 6-cylinder petrol engine, 375 kW (510 hp), 19"/20" M forged wheels Double-spoke style 825 M Orbit Grey matt with mixed tyres, exterior paintwork in BMW Individual Frozen Portimao Blue metallic, BMW Laserlight, M Carbon bucket seats in full leather Merino finely structured Silverstone/Black, Carbon Fibre M interior trim.

The models illustrated in this medium show the equipment and configuration options (standard and optional) for vehicles produced by BMW AG for the German market. Alterations in standard and optional equipment and the configurations available for the different models, as described in this medium, may occur after 30/04/2021, the editorial deadline for this medium, or according to the specific requirements of other member states of the European Union. Your local BMW Partner is available to provide further details. Subject to change in design and equipment. Of course, each vehicle is designed for economical recycling after its long-running life. You can find more information regarding your end-of-life vehicle on our website [www.bmw.de/recycling](http://www.bmw.de/recycling).

© BMW AG, Munich, Germany. Not to be reproduced wholly or in part without prior written permission of BMW AG, Munich.

411 999 066 36 1 2021 CB. Printed in Germany 2021.